

# G400-D SoM

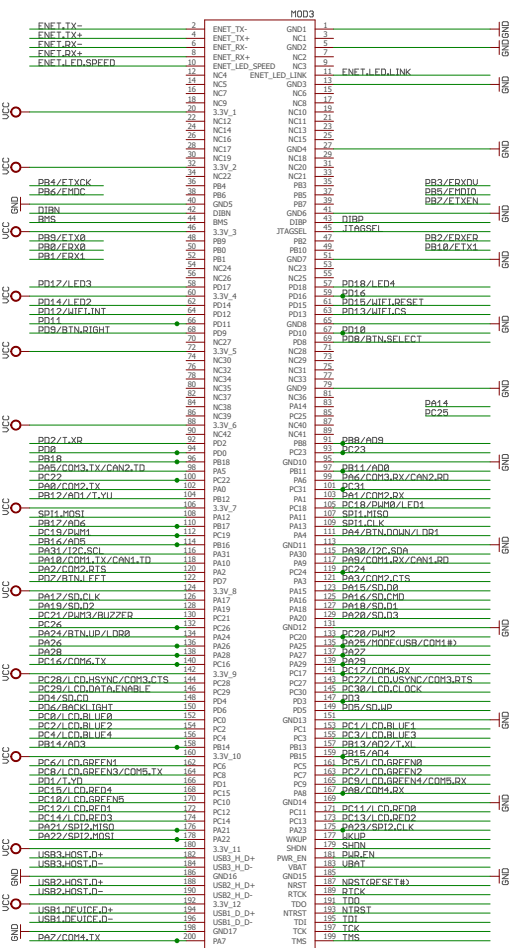

## WiFi

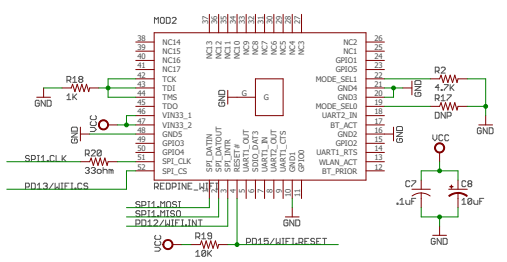

## Ethernet

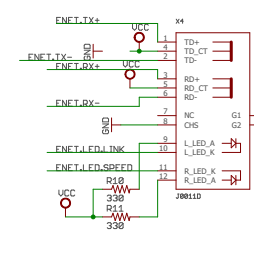

## Buttons

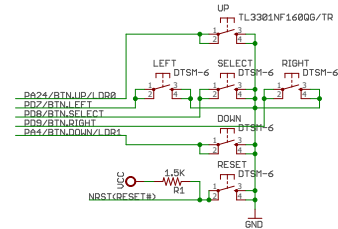

## 4.3" Display

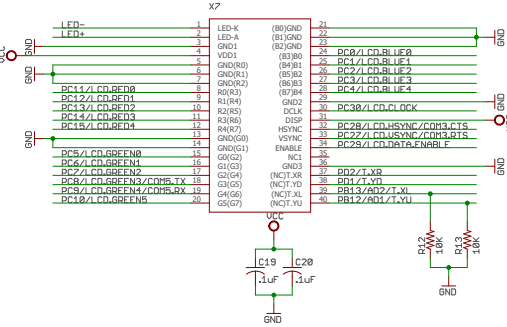

## USB VCOM1

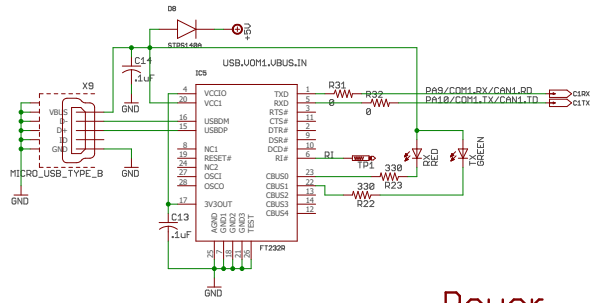

## Power

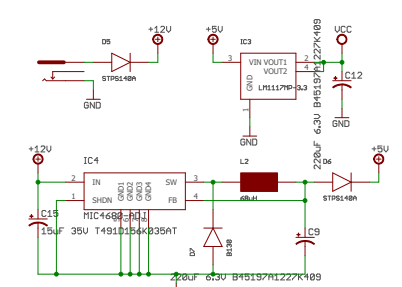

## Backlight

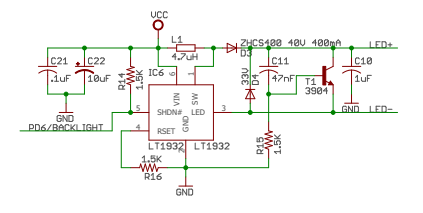

GHI Electronics, LLC  
G400-D Dev Board

## Header

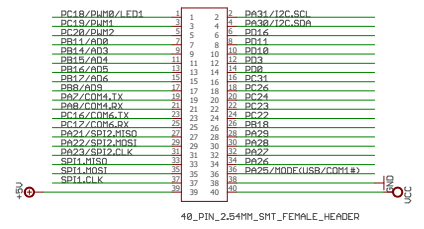

## SD/MMC memory card

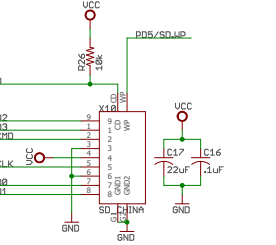

## RS232 DTE (PC)

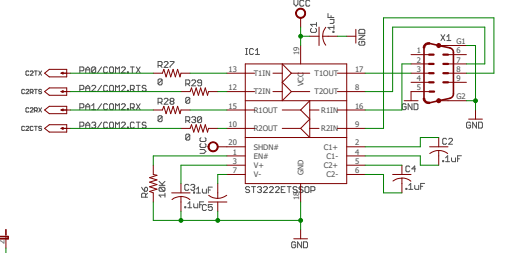

## USB Host

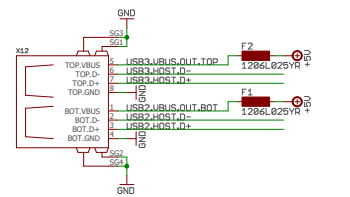

## USB Device

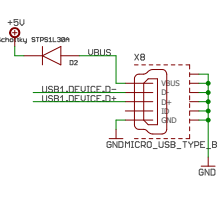

## LEDs

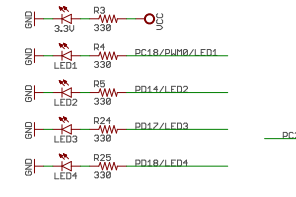

## Buzzer

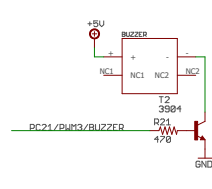

## CAN

