

MCU G80 SoC

User IOs

Power

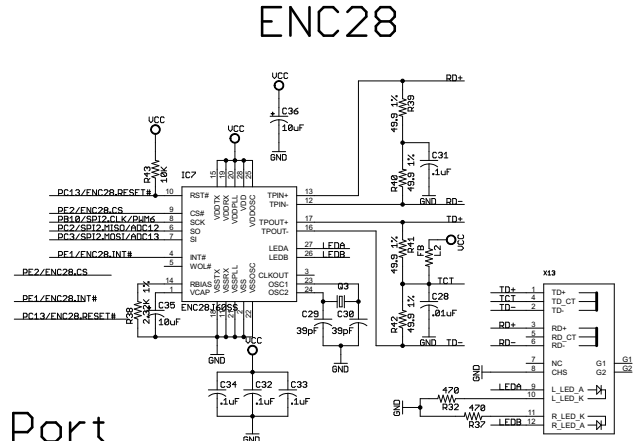
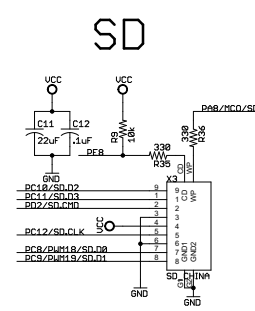
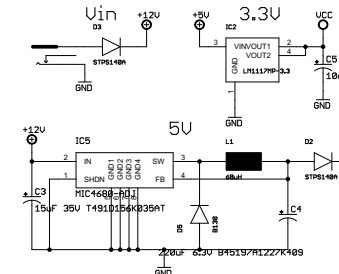
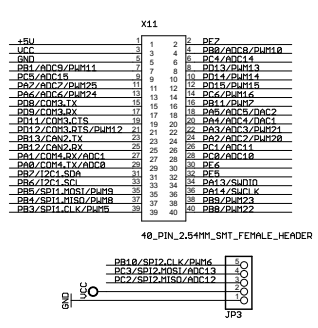
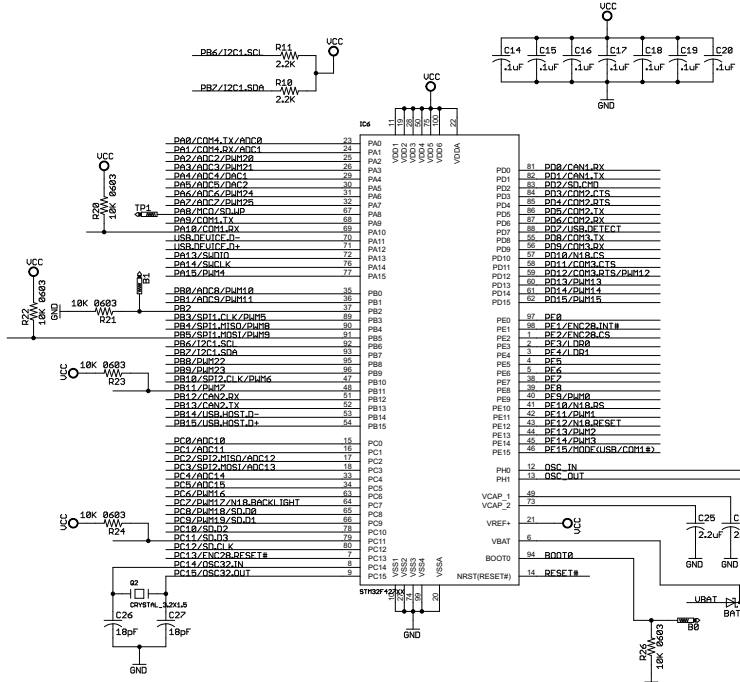

USB Debug

LCD

USB Virtual Serial Port

LEDs

Buttons

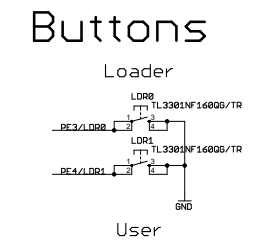
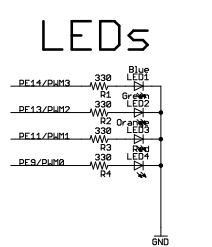
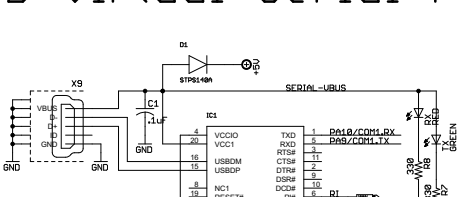
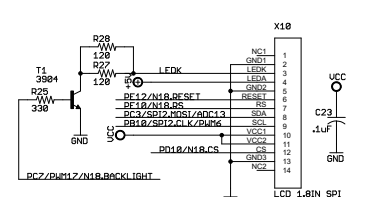
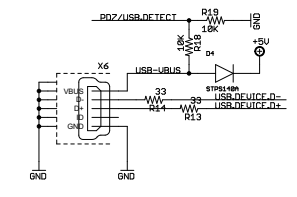

USB Host

RS232 DTE (PC)

Buzzer

VBAT

Mode

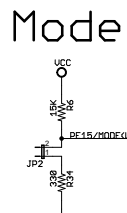
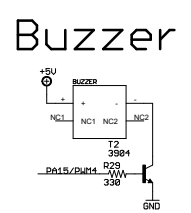
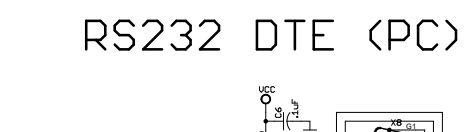
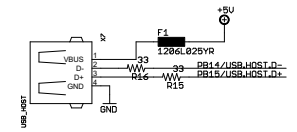

User

Reset

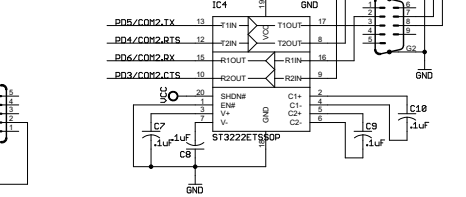
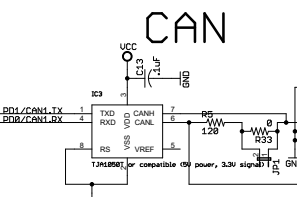
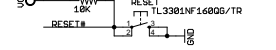

GHI Electronics, LLC G80 Dev Board	
TITLE: G80 Dev Board	REV:
Document Number:	REV:
Date: 6/24/2015 9:36:00 AM	Sheet: 1/1